



Gas filled thermometers FTh 100 Ch

Part no. 64401432

gas filled thermometer for chemical applications

benefits

- for chemical, process engineering and food industry applications
- high measuring accuracy
- fast response

Application

For corrosive media. Meets the most exacting measuring demands, e.g. in process engineering as well as chemical and food industry applications.

Technical Specifications

Type

D4

Nominal size

100

Measuring principle

Pressurised gas filling

accuracy class

1 (EN 13190)

ranges °C

0/500

Application area (EN 13190)

continuous load: Full scale value

short-term: 1.1 x full scale value

Operating pressure at thermowell

max. 10 bar (Up to 300 °C)

Degree of protection

IP 65 (EN 60529)

Connection

Stem: Stainless steel 321, Ø 10 mm, plain

mounting position

bottom

Dial

Aluminium, white

Scaling: black

Pointer

Aluminium, black

Zero correction

at the side

movement
Brass

bayonet bezel
Stainless steel 304

Housing
Stainless steel 304

window
Instrument glass

Options

- Every angle version
- Grooved nut connection as per DIN 11851
- other connection designs
- other nominal sizes
- other ranges
- special scales
- Glycerine filling (type D8)
- back flange
- 3-hole fixing, panel mounting bezel
- Capillary (stainless steel 321)
- special materials
- Electrical contacts

Technical Drawings

Version with capillary and 3-hole fixing, panel mounting bezel

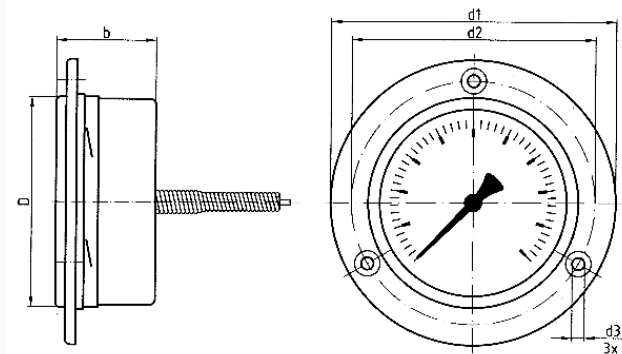

Dimensions (mm)

NG	b	D	d1	d2	d3
100	45	101	132	116	5,5
160	45	161	196	178	6

Versions

Type	housing \varnothing	Range	Type	Type	Part no.
FTh 100 Ch	100 mm	0/500 °C	FTh 100 Ch	D432	64401432

- in-stock items
- Non-stock items