

Gas filled thermometers FTh 160 Ch

Part no. 64379482

gas filled thermometer for chemical applications

benefits

- for chemical, process engineering and food industry applications
- high measuring accuracy
- fast response

Application

For corrosive media. Meets the most exacting measuring demands, e.g. in process engineering as well as chemical and food industry applications.

Technical Specifications

Type

D4

Nominal size

160

Measuring principle

Pressurised gas filling

accuracy class

1 (EN 13190)

ranges °C

0/160

Application area (EN 13190)

continuous load: Full scale value
short-term: 1.1 x full scale value

Operating pressure at thermowell

max. 10 bar (Up to 300 °C)

Degree of protection

IP 65 (EN 60529)

Connection

Stem: Stainless steel 321, Ø 10 mm, plain

mounting position

every angle version

Dial

Aluminium, white
Scaling: black

Pointer

Aluminium, black

Zero correction

at the side

movement

Brass

Housing

Stainless steel 304

bayonet bezel

Stainless steel 304

window

Instrument glass

Options

- Every angle version
- Grooved nut connection as per DIN 11851
- other connection designs

- other nominal sizes
- other ranges
- special scales
- Glycerine filling (type D8)
- back flange
- 3-hole fixing, panel mounting bezel
- Capillary (stainless steel 321)
- special materials
- Electrical contacts

Technical Drawings

Every angle version

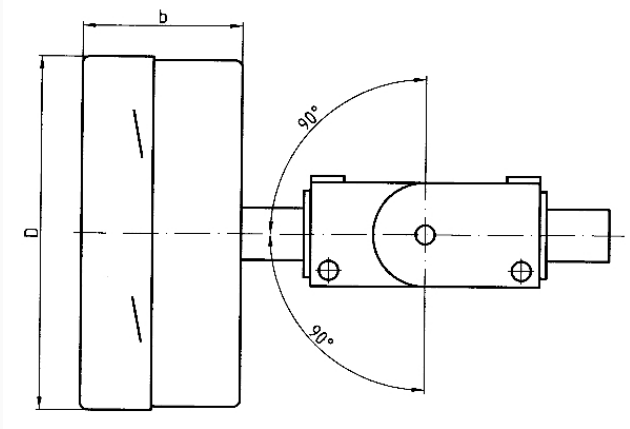

Dimensions (mm)

NG	b	D
100	45	101
160	45	161

Versions

Type	housing ø	Range	Type	Type	Part no.
FTh 160 Ch	160 mm	0/160 °C	FTh 160 Ch	D482	64379482

- in-stock items
- Non-stock items