



Capsule pressure gauges for chemical applications KP160Ch

Part no. 35156432

Capsule pressure gauges for chemical applications Type D4

benefits

- with zero correction
- robust stainless steel housing (with bayonet bezel)
- wetted parts and movement made of stainless steel
- GOSSTANDART-certified
- Ex version (optional)

Application

For corrosive gaseous and dry media, also for use in corrosive environments.

Technical Specifications

Type

D4

Nominal size

160

accuracy class (EN 837-3/6)

1.6

ranges (EN 837-3/5)

see ordering table

application area

static load: Full scale value
dynamic load: 0.9 x full scale value
overload safety: 1.3 x full scale value

Operating temperature range

Medium: max. 100 °C
Ambient: -20/+60 °C

Temperature performance

Indication error when the temperature of the measuring system deviates from the normal temperature of 20 °C:
at rising temperature approx. ± 0.6 %/10 K
falling temperature approx. ± 0.6 %/10 K
of full scale value

Degree of protection

IP 32 (EN 60529)

Connection

stainless steel 316 Ti/316 L, centre back

Measuring element

Capsule element, stainless steel 316 Ti/316 L

movement

Stainless steel

Zero correction

from the front

Seal
FKM (Viton)

Dial
Aluminium, white
Scaling: black

Pointer
Aluminium, black

Housing
Stainless steel 304

bayonet bezel
Stainless steel 304

window
D432
Plastic (PMMA)

Options

- back flange
- Panel mounting bezel
- 3-hole fixing, panel mounting bezel
- Ex version
- throttle screw
- special scales
- other process connections

Technical Drawings

Centre back connection, 3-hole fixing, panel mounting bezel

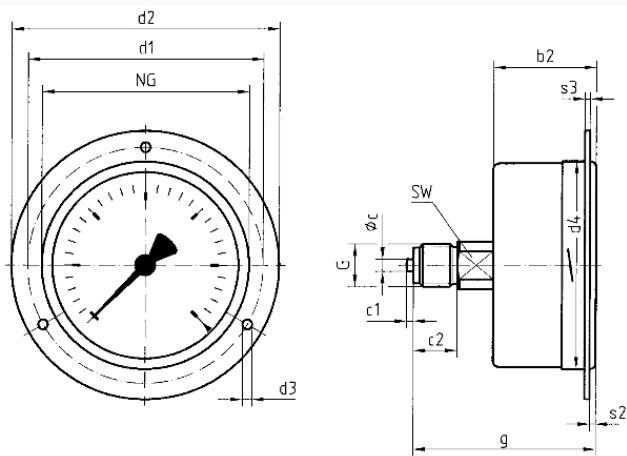

Dimensions (mm)

NG	b2	∅c	c1	c2	d1*	d2	d3*	d4	G	g	s2	s3	SW
63	37	5	2	13	75	85	3,5	64	G½B	60	3	2	14
100	49	6	3	20	116	132	4,8	104	G½B	81	4	2	22
160	50	6	3	20	178	196	5,8	164	G½B	82	4	2	22

* Dimensions for NG 100 according to DIN 16014

Versions

Range	Mounting type	Type		Part number
-60/+0 mbar	3-hole fixing, panel mounting bezel	KP160Ch D432	<input type="radio"/>	35156432

- in-stock items
- Non-stock items