

Bourdon tube pressure gauges for chemical applications RF160Ch

Part no. 85273432

Bourdon tube pressure gauges for chemical applications Type D4

benefits

- for chemical and process engineering applications
- measuring system fully welded to housing
- extremely robust design
- for temperatures of the medium of up to 200 °C
- tightness-tested with helium
- DNV- and GOSSTANDART-certified
- Ex version (optional)

Application

For corrosive gaseous and liquid media which are not highly viscous and do not crystallise; suitable for corrosive environments.
! For measuring gas or vapour, observe the table "Selection Criteria as per EN 837-2"!

Technical Specifications

Type
D4

Nominal size
160

accuracy class (EN 837-1/6)
1.0

ranges (EN 837-1/5)
see ordering table

Application area NG100/160
 ≤ 600 bar: Full scale value
 > 600 bar: $\frac{3}{4}$ x full scale value
 ≤ 600 bar: 0.9 x full scale value
 > 600 bar: $\frac{2}{3}$ x full scale value
 ≤ 600 bar: 1.3 x full scale value
 > 600 bar: Full scale value

Operating temperature range

Medium: max. 200 °C
Ambient: -20/+60 °C

Temperature performance

Indication error when the temperature of the measuring system deviates from the normal temperature of 20 °C:
 at rising temperature approx. ± 0.4 %/10 K
 falling temperature approx. ± 0.4 %/10 K
 of full scale value

Degree of protection

IP 65 (EN 60529)

Connection

Stainless steel 316 L, bottom back
 $G\frac{1}{2}B$, SW22 (EN 837-1/7.3)

Measuring element

Bourdon tube, stainless steel 316 Ti/316 L
 ≤ 60 bar: "C" type tube
 > 60 bar: helical tube
 tightness-tested with helium

movement

Stainless steel

Dial

Aluminium, white
 Scaling: black

Pointer

Aluminium, black

Housing

Stainless steel 304, with blow-out

bayonet bezel

Stainless steel 304

window

Laminated safety glass

Options

- back flange
- Panel mounting bezel
- 3-hole fixing, panel mounting bezel
- Ex version
- Crimped bezel, polished
- Electrical contacts
- special scales
- other process connections

Technical Drawings

bottom back connection, 3-hole fixing, panel mounting bezel

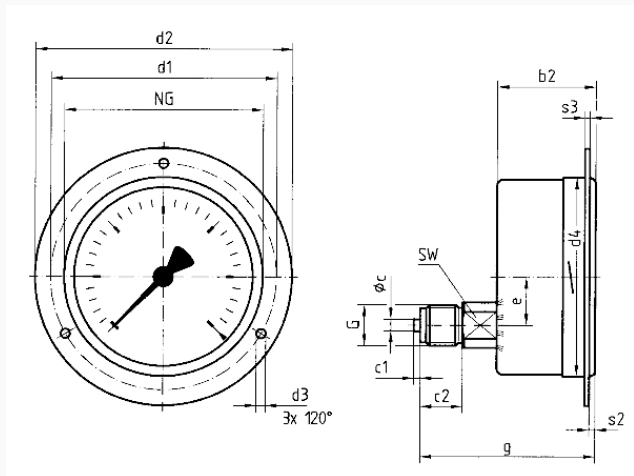

Dimensions (mm)

NG	b2	∅c	c1	c2	d1*	d2*	d3*	d4	e	G	g	s2	s3	SW
100	49	6	3	20	116	132	4,8	104	34,5	G½B	83	4	2	22
160	50	6	3	20	178	196	5,8	164	34,5	G½B	84	4	2	22

* Dimensions as per DIN 16064

Versions

Range	Mounting type	Type		Part number
0/400 bar	3-hole fixing, panel mounting bezel	RF160Ch D432	●	85273432

- in-stock items
- Non-stock items