

Precision Bourdon tube pressure gauges RF160ChF

Part no. 85723402

Precision Bourdon tube pressure gauges

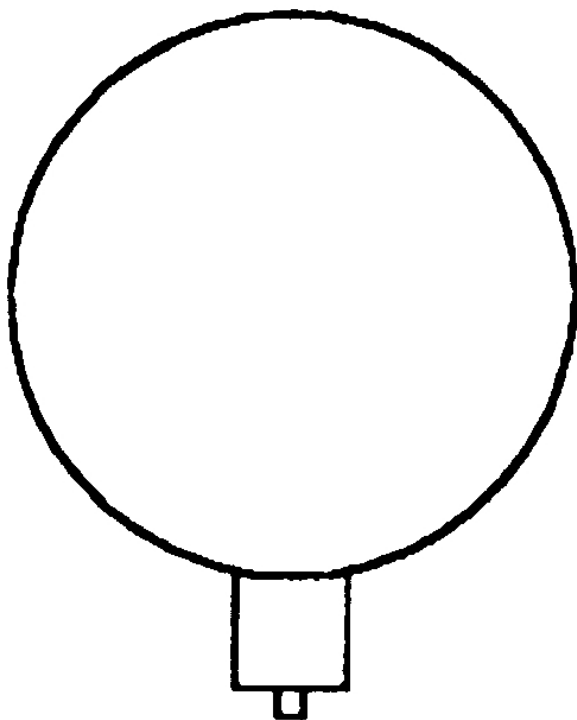

Technical Specifications

Type

D4

Nominal size

160

accuracy class (EN 837-1/6)

0.6

ranges

see ordering table

application area

static load: $\frac{3}{4}$ x full scale value
dynamic load: $\frac{2}{3}$ x full scale value
short-term: Full scale value

Operating temperature range

Ambient: -20/+60 °C

Degree of protection

IP 54 (EN 60529)

Connection

stainless steel 316 Ti/316 L, bottom

Measuring element

Bourdon tube

≤ 60 bar: "C" type tube, stainless steel 316 Ti/316 L

> 60 bar: helical tube, stainless steel 316 Ti/316 L

movement

Brass/nickel silver, jewel bearing

Dial

Aluminium, white

Scaling: black

NG 160

Pointer

knife edge pointer

Aluminium, black

Housing

Stainless steel 304

bayonet bezel

Stainless steel 304

window

Plastic (PMMA)

Technical Drawings

Bottom connection

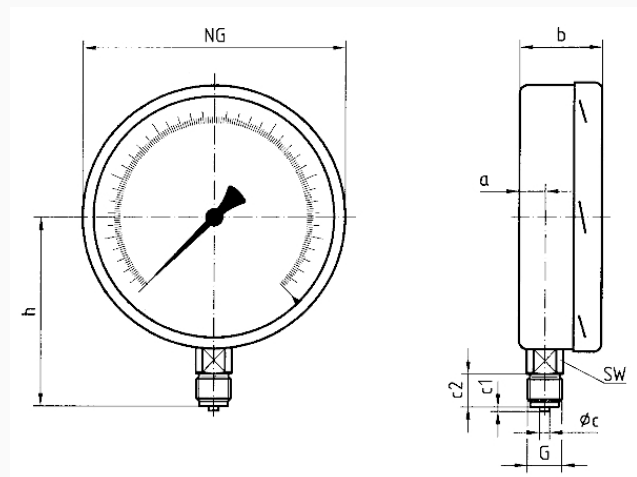

Dimensions (mm)

NG	a	b	øc	c1	c2	G	h	SW
160	17,5	50	6	3	20	G½B	116	22
250	16	57	6	3	20	G½B	165	22

Versions

Range	Mounting type	Type	Part number
0/400 bar	direct	RF160ChF D402	85723402

- in-stock items
- Non-stock items