

Bourdon tube safety pressure gauges RF160Si

Part no. 85518402

Bourdon tube safety pressure gauges Type D4

benefits

- Safety housing S3 as per EN 837-1/9.7.2
- measuring system fully welded to housing
- tightness-tested with helium
- DNV- and GOSSTANDART-certified
- Ex version (optional)

Application

For corrosive gaseous and liquid media which are not highly viscous and do not crystallise; suitable for corrosive environments. This gauge is designed for applications as per EN 837-1/9.7.2.

Technical Specifications

Type

D4

Nominal size

160

accuracy class

EN 837-1/6

NG 160

1.0

ranges (EN 837-1/5)

see ordering table

application area

≤ 600 bar: Full scale value

> 600 bar: ¼ x full scale value

≤ 600 bar: 0.9 x full scale value

> 600 bar: ⅔ x full scale value

≤ 600 bar: 1.3 x full scale value

> 600 bar: Full scale value

Operating temperature range

Medium: max. 100 °C

Ambient: -20/+60 °C

Degree of protection

IP 54 (EN 60529)

Connection

Stainless steel 316 L, bottom

Measuring element

Bourdon tube

stainless steel 316 Ti/316 L

≤ 60 bar: "C" type tube

> 60 bar: helical tube

tightness-tested with helium

movement

Stainless steel

Dial
Aluminium, white
Scaling: black

Pointer
Aluminium, black

Housing
Stainless steel 304, with solid baffle wall and blow-out (S3)

Options

- Glycerine filling (bottom version type D8)
- 3-hole fixing, panel mounting bezel
- Ex version
- special scales
- other process connections

bayonet bezel
Stainless steel 304

window
Laminated safety glass

Technical Drawings

NG 100/160 – bottom connection

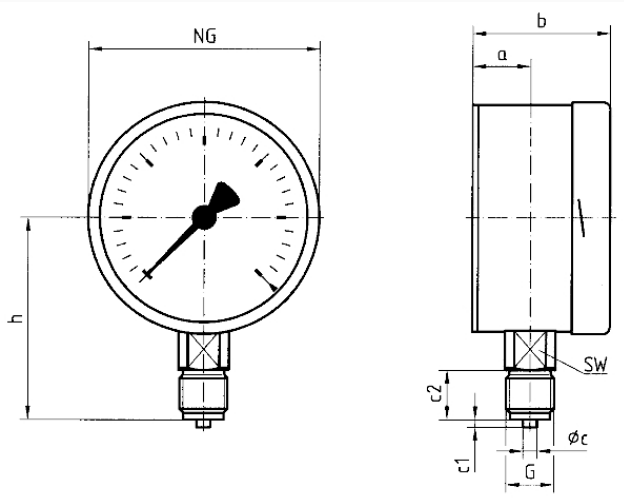

Dimensions (mm)

NG	a	b	Øc	c1	c2	G	h	SW
100	27	60	6	3	20	G½B	86	22
160	40	78	6	3	20	G½B	118	22

Versions

Range	Mounting type	Type	Part number
0/40 bar	direct	RF160Si D402	85518402

- in-stock items
- Non-stock items