

Pressure transducers DMU 03 VM

Part no. 31168

Pressure transducers DMU 03 Industrial version



benefits

- for low pressure ranges
- Versions for relative pressure and absolute pressure
- excellent long-term stability
- Ex version (optional)
- Option SIL 2

Application

For electronic pressure measurement in mechanical and plant engineering as well as process engineering applications. With flush diaphragm, the pressure transducers are also suitable for use with viscous, highly viscous media.

Description

Pressure transducers convert physical pressure into an electrical signal proportional to the pressure. DMU 03 is equipped with an oil-filled piezo-resistive silicon measuring cell. DMU 03 has safety integrity level SIL 2 (IEC 61508/61511).

Technical Specifications

Measuring accuracy

Deviation from the characteristic curve according to IEC 60770 – limit point calibration (non-linearity, hysteresis, repeatability)

< ± 0.35 % FSO

Measuring range

0/1 bar

Overpressure safety

at least 3 x FS

Burst pressure

at least 5 x FS

Operating temperature range

Medium: -40/+125 °C

Ambient: -40/+85 °C

Storage: -40/+100 °C

Temperature error band

$P_N \leq 60$ bar

≤ ± 0.75 % FSO In compensated range -20/+85 °C

dynamic characteristics

Response time: ≤ 10 ms

Process connection

G½B DIN 3852 type E

material

Housing: Stainless steel 316 L
DMU 03 VM
Stainless steel 316 L
DMU 03 VM
Stainless steel 316 L
Seal: FKM (Viton)

pressure transmission liquid

Silicone oil

Supply voltage

DMU 03 VM
DC 8 – 32 V

Output signal

2-wire, 4–20 mA

Load

$R_{\max} = [(UB - UB_{\min})/0.02 \text{ A}] \Omega$

Options

- other process connections
- other electrical connections
- Field housing (stainless steel 303)
- other seal materials
- higher accuracy and overpressure safety
- Fitting of chemical seal
- EX version (II 1G Ex ia IIC T4 Ga, II 1D Ex ia IIIC T85°C Da)
- SIL 2 (IEC 61508/61511) 2-wire

Current input

< 25 mA

electrical protection

short circuit proof and protected against reverse polarity

Electrical connection

Connector and junction box as per ISO 4400 (DIN 43650-A)

Degree of protection

IP 65 (EN 60529)

CE conformity

EMC Directive 2014/30/EU
RoHS Directive 2011/65/EU
Pressure Equipment Directive 2014/68/EU

Technical Drawings

DMU 03 VM - Connection G1/2B DIN 3852 type E with protruding diaphragm

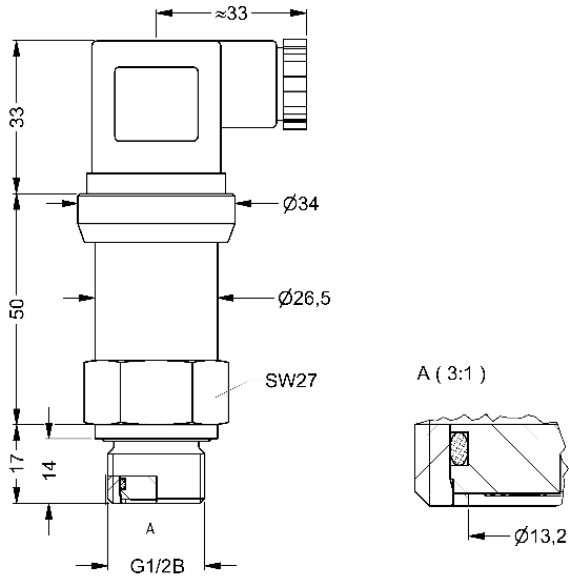

Dimensions (mm)

Versions

Range	Measuring range	Type	Version	Part no.
	0/1 bar	DMU 03 VM	●	31168

- in-stock items
- Non-stock items