



## Pressure transducers DMU 04 MR

Part no. 31732

Pressure transducers DMU 04 Industrial version

### benefits

- DMU 04 CP/MR for hygienic processes
- small temperature error
- Options: Ex, field housing or high temperature version (up to 300 °C) and SIL 2

### Application

For applications requiring hygienic process connections, materials or processing, especially food technology, pharmaceutical and biotechnology applications.

### Description

Pressure transducers convert physical pressure into an electrical signal proportional to the pressure. DMU 4 is equipped with an oil-filled piezo-resistive silicon measuring cell. DMU 04 has safety integrity level SIL 2 (IEC 61508/61511).

### Technical Specifications

#### Measuring accuracy

Deviation from the characteristic curve according to IEC 60770 – limit point calibration (non-linearity, hysteresis, repeatability)  
 $< \pm 0.35 \% \text{ FSO}$

#### Measuring range

0/6 bar

#### Overpressure safety

at least 3 x FS

#### Burst pressure

at least 5 x FS

#### Operating temperature range

Medium:  $-10/+125 \text{ }^\circ\text{C}$

Medium: short-term (60 min) up to  $150 \text{ }^\circ\text{C}$

Ambient:  $-40/+85 \text{ }^\circ\text{C}$

Storage:  $-40/+100 \text{ }^\circ\text{C}$

#### Temperature error band

$\geq 400 \text{ mbar}$

$\leq \pm 0.75 \% \text{ FSO}/10 \text{ K}$  In compensated range  $-20/+85 \text{ }^\circ\text{C}$

#### dynamic characteristics

Response time:  $\leq 10 \text{ ms}$

#### Process connection

Conical dairy fitting DN 25 DIN 11851

**material**

Housing: Stainless steel 316 L  
pressure connection: Stainless steel 316 L  
diaphragm: Stainless steel 316 L

**pressure transmission liquid**

Food oil, FDA-compliant

**Supply voltage**

DC 8 – 32 V

**Output signal**

2-wire, 4–20 mA

**Load**

$R_{\max} = [(UB - UB_{\min})/0.02 \text{ A}] \Omega$

**Current input**

< 25 mA

**electrical protection**

short circuit proof and protected against reverse polarity

**Electrical connection**

Connector and junction box as per ISO 4400 (DIN 43650-A)

**Degree of protection**

IP 65 (EN 60529)

**CE conformity**

EMC Directive 2014/30/EU

RoHS Directive 2011/65/EU

Pressure Equipment Directive 2014/68/EU

**Options**

- other process connections
- other electrical connections
- Field housing (stainless steel 303)
- High temperature version up to 300 °C
- higher accuracy
- Union nut DN 25/40/50
- EX version (II 1G Ex ia IIC T4 Ga, II 1D Ex ia IIIC T85°C Da)
- SIL 2 (IEC 61508/61511) 2-wire

**Technical Drawings**

**DMU 04 - dairy cone DIN 11851 DN 25**

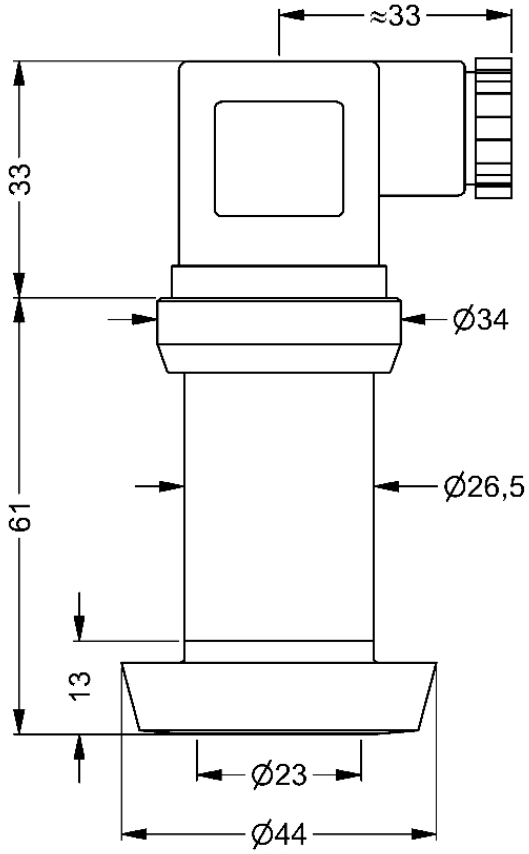

**Dimensions (mm)**

**Versions**

Range	Measuring range	Type	Version	Part no.
	0/6 bar	DMU 04 MR	●	31732

- in-stock items
- Non-stock items