

Safety temperature cut outs STB LS1/971 FU

Part no. 67277X

Safety temperature cut outs STB With capillary tube



benefits

- ideal for heating and process industries
- for protection against exceeding the maximum temperature
- no external power supply
- manual reset

Application

There are many application areas for safety temperature cut outs in the heating and process industries. In conventional oil-fired or gas-fired boilers, these devices are used to monitor the boiler water. The safety temperature cut outs feature a manual reset button which must be actuated for unlocking.

Description

If the temperature at the probe increases, the measuring liquid in the measuring system expands. If the temperature exceeds a critical value, the device triggers, the voltage-free contact switches and the system is set to a defined safe state. When the temperature has decreased by approx. 15 K, the device can be unlocked and the system resumes operation.

Technical Specifications

Type

LS1

Switching point

see ordering table

Tolerance

+0 K/-6 K at 20 °C

Influence of ambient temperature

0.25 °C/°C

Switching differential

$\Delta T 15 \pm 8 K$

Fail safe

1

Probe

Copper
Ø 6.5 x 95 mm

Probe element

liquid-filled

Operating temperature range

Probe: max. 125 °C
Housing: max. 85 °C

Capillary tube

Cu capillary tube with PVC coating, black
Length: 1500 mm

Degree of protection

IP 00 (EN 60529)

Time constant

DIN-tested
DIN EN 14597:2012-09
registration number: TR/STB 1211

electrical switching contact

Changeover contact

Contact rating

NC: AC 250 V, 16 (2.5) A
NO: AC 250 V, 0.5 A

Options

- other operating ranges
- other capillary tube lengths
- customised versions

Technical Drawings

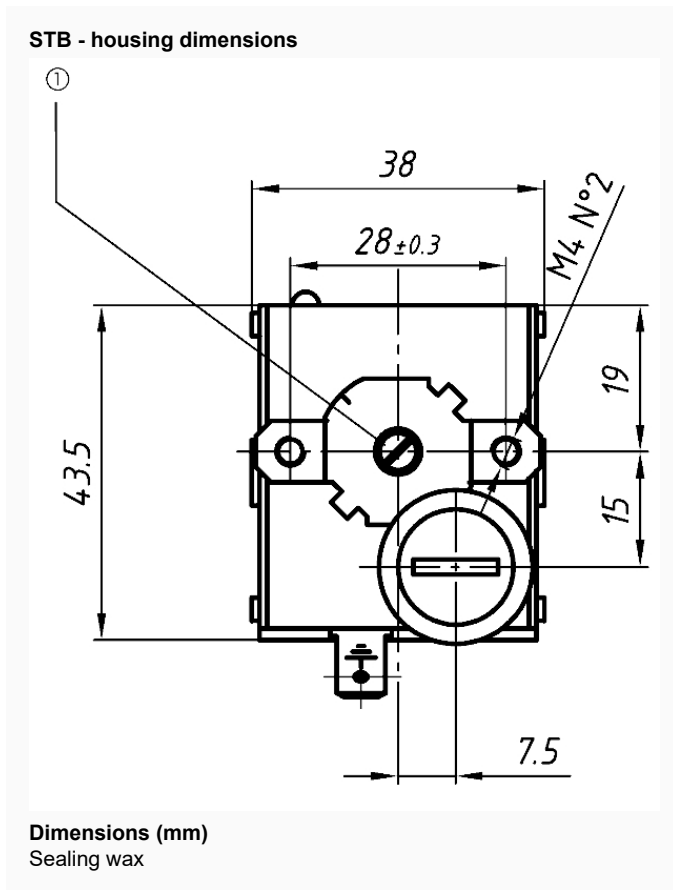

Versions

	Contact	Switching point	Switching point	capillary length		Part no.
Safety temperature cut outs STB LS1/971 FU	Changeover contact	100 °C		1500 mm	●	67277X

- in-stock items
- Non-stock items