

## bimetal stainless steel thermometer BiTh 63 E

Part no. 66152312AFG4D8

bimetal stainless steel thermometer BiTh E

### benefits

- suitable for use in mechanical engineering, plant engineering, process engineering or food industry
- ideal for hygienic processes
- accuracy class 1 as per EN 13190
- for temperatures of the medium of up to 160 °C
- with adapter ring for thermowell Ø 18 mm

### Application

For corrosive media. Suitable for a great range of industrial applications.

### Technical Specifications

#### Type

D3

#### Nominal size

63

#### measuring element

Bimetal helix

#### accuracy class

1 (EN 13190)

#### ranges °C

0/160

#### Application area (EN 13190)

continuous load: Measuring range

short-term: Range

#### Operating pressure at thermowell

(not included in scope of delivery)

max. 25 bar

#### Degree of protection

IP 43 (EN 60529)

#### Connection

Stem: Stainless steel 316 L, Ø 8 mm

Stem: fixed male connection, fixed G $\frac{1}{2}$ B

#### mounting position

centre back

#### Dial

Aluminium, white

Scaling: black

#### Pointer

Aluminium, black

#### Housing

Stainless steel 304

#### push on bezel

Stainless steel 304

#### window

Instrument glass

### Options

- Thermowell G $\frac{1}{2}$ B, stainless steel 316 Ti/316 L
- other connection designs
- other ranges

- other stem lengths

**Technical Drawings**

**centre back connection, fixed male connection**

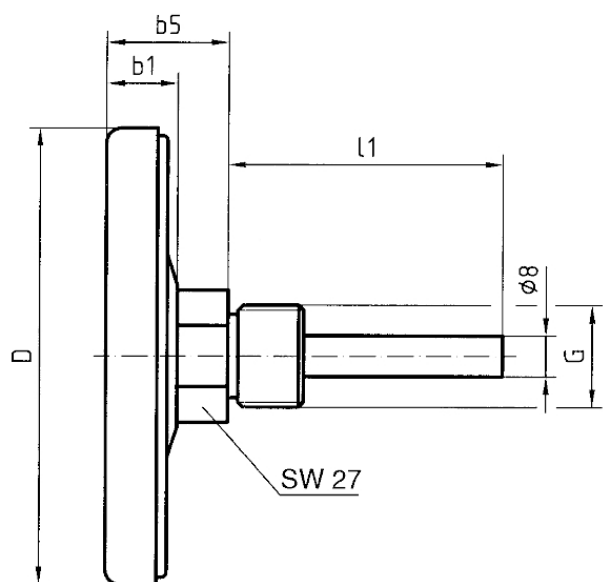

**Dimensions (mm)**

NG	D	b1	b5	l1	G
63	63	15	27	63	G $\frac{1}{2}$ B
63	63	15	27	80	G $\frac{1}{2}$ B
63	63	15	27	100	G $\frac{1}{2}$ B
80	80	15	28	63	G $\frac{1}{2}$ B
80	80	15	28	80	G $\frac{1}{2}$ B
80	80	15	28	100	G $\frac{1}{2}$ B
100	100	17	29	63	G $\frac{1}{2}$ B
100	100	17	29	80	G $\frac{1}{2}$ B
100	100	17	29	100	G $\frac{1}{2}$ B

**Versions**

Type	housing ø	moun- ting po- sition	Connec- tion	Range	For ther- mowell with length L1	Stem length L1	Type	Type	Part no.
BiTh 63 E	63 mm	centre back	fixed male connec- tion, fixed G½B	0/160 °C		63 mm	BiTh 63 E	D312	● 66152312AF- G4D8

● in-stock items

● Non-stock items